



1400mA LED Driver w/ Tuning

- Universal input voltage 120 – 277 Vac
- 0-10V Dimming
- Thermal Foldback Control

Performance

Input Voltage	120 ~ 277 Vac
Input Current Max	1.40 /120V 0.59/277V
Input Power Max	165W /120V 161W/277V
Input Frequency	50 - 60 (Hz)
Power Factor	> 0.95
THD max	< 20 %
Output Voltage	38V-107V
Output Current	140-1400mA
Output Power	150W Max
Line Regulation	±1 %
Load Regulation	±3 %
Output Current Ripple	<10%
Inrush Current	120V: 31A / 210uS
Peak / >50% Duration	277V: 74A / 200uS

- * Refer to charts for additional information
- Harmonic Emissions comply with ANSI C82.77
- Inrush current complies with NEMA 410

Environmental

EMI and RFI	Meets FCC part 15 (Class A) Non-Consumer Limits
Minimum Operating Temperature	-40°C (-40°F)
Storage Temperature	-40°C to 85°C
tc	(-40°F to 185°F)
tc	85°C (185°F) max
Location Rating	UL Dry & Damp, Type HL
Transient Protection	IEEE C62.41 6kV**

**Driver uses MOVs for transient protection.
Refer to application note EVD07 at www.unvlt.com for additional information on Hi-Pot Testing.

Physical

Length	9.50 in (241.3 mm)
Width	2.40 in (61.0 mm)
Height	1.55 in (39.4 mm)
Mounting Length	8.89 in (225.8 mm)
Weight (lbs)	2.6
Lead Lengths	
Blk, Wht, Blk/Wht, Blu/Wht	11.5 +/- 1.0 in
Red(+), Blue(-), Pink*, Violet	11.5 +/- 1.0 in

Lead-wires are 18 AWG 105°C /600V solid copper.

Protection

Over voltage, Overload and short circuit, over temp.

Safety:

UL 8750 & CSA 250.13
UL Class P

Ordering Information

Order Number	Description	Qty/Carton
D14CC150UVT-F20KC	Standard Product	10
D14CC150UVT-FR00C	Rated IP66	10

*Consult Factory for Tuning ordering information

Wiring Diagram:

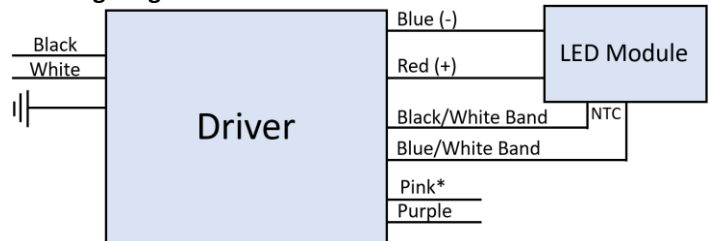

- **NOTE:** Unused Black/White and Blue/White leads must be individually capped off when thermal foldback control is not used.
- * **Note:** The Gray has been changed to Pink for the negative 0-10V dimming control lead.



Application and operation performance specification information subject to change without notification.

Programmable Tuned Output Settings

- This Everline LED Driver can be configured to set its current output to a selected fraction of their maximum rated design level. This function is called tuning (or also high-end trim) and it can be implemented with the LDTC01A using the Selector rotary switches. Tuning assignments are stored in driver memory and are not lost when power is removed. All factory produced drivers are tuned to maximum output unless otherwise noted on the label.
- Tuning SET Levels are listed in the table to the right. The SET Level corresponds to an associated Output Current value.
- Tuned output tolerance of $\pm 5\%$.
- Refer to application note EVD06 at www.unvlt.com for additional information.

Set Value	Output Current (A)
100	1.400
99	1.381
98	1.362
97	1.343
96	1.325
95	1.306
94	1.287
93	1.269
92	1.250
91	1.232
90	1.213
89	1.195
88	1.177
87	1.159
86	1.141
85	1.123
84	1.105
83	1.088
82	1.070
81	1.052

Set Value	Output Current (A)
80	1.035
79	1.018
78	1.000
77	0.983
76	0.966
75	0.949
74	0.933
73	0.916
72	0.899
71	0.883
70	0.867
69	0.850
68	0.834
67	0.818
66	0.802
65	0.787
64	0.771
63	0.756
62	0.741
61	0.725

Set Value	Output Current (A)
60	0.710
59	0.695
58	0.681
57	0.666
56	0.652
55	0.637
54	0.623
53	0.609
52	0.596
51	0.582
50	0.568
49	0.555
48	0.542
47	0.529
46	0.516
45	0.503
44	0.491
43	0.479
42	0.467
41	0.455
40	0.443

Application and operation performance specification information subject to change without notification.

0-10V Dimming

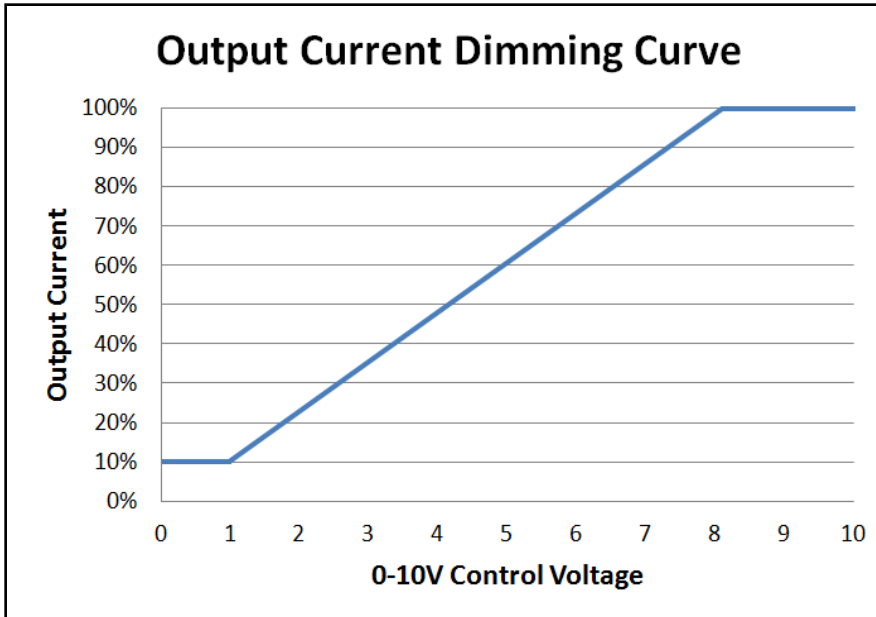

0-10V Analog Dimming Interface

- Analog 0 to 10 vDC Voltage Control
- Use Violet (+) & Pink* (-) for connection to 0-10vDC.
- 10v = maximum output, 0v = minimum output
- Wiring Violet & Pink* together provides min. light output.
- Capping Violet & Pink* separately provides 100% light output.
- 0-10V interface can be wired as Class 1 or Class 2 Circuit.
- Driver will source a maximum of 200uA for control needs.
- Controller must sink current from the 0-10V control leads.

Application and operation performance specification information subject to change without notification.

Performance: Efficiency, THD, & Power Factor

Typical performance measurements are shown. The charts are to be used as a guideline and not for specification use.

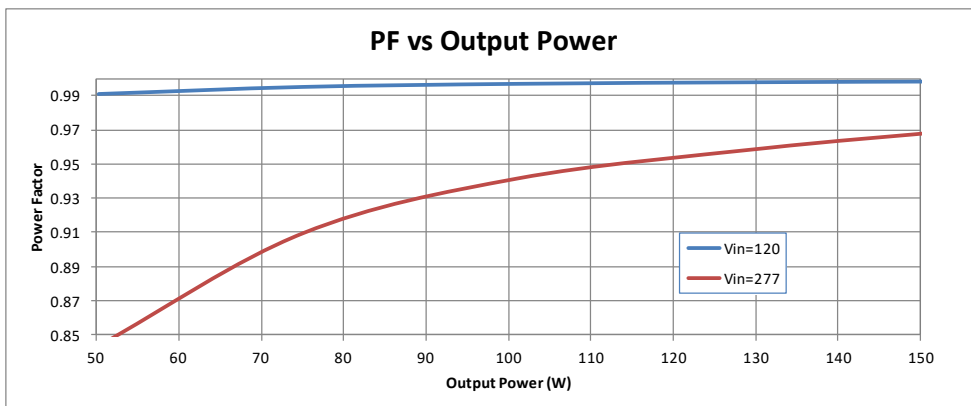
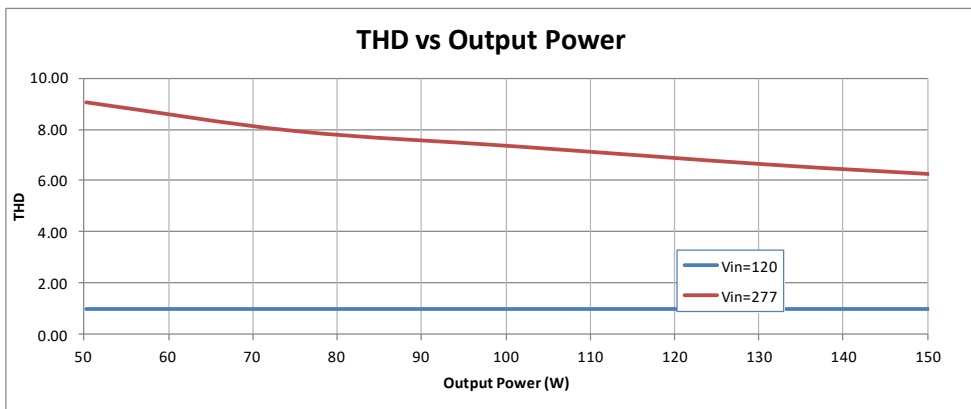
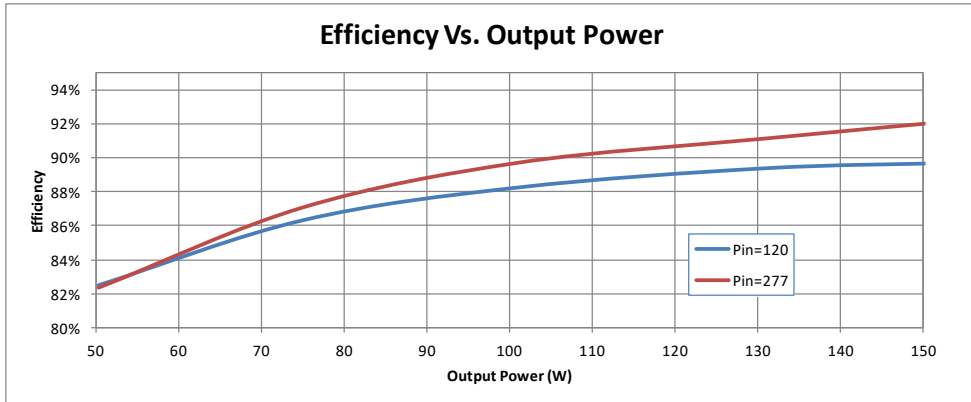

Output power based on maximum rated output current and varying load voltages.

Application and operation performance specification information subject to change without notification.

Module Thermal Foldback Protection

Thermal Foldback Control

- Luminaire temperature monitoring/protection
- LED Driver reduces output current for external thermal protection if an NTC (Negative Thermal Coefficient) is connected to the Black/White and Blue/White leads.
- **NOTE:** Unused Black/White and Blue/White leads must be individually capped off when thermal foldback control is not used.
- See application note on www.unvlt.com for more information.

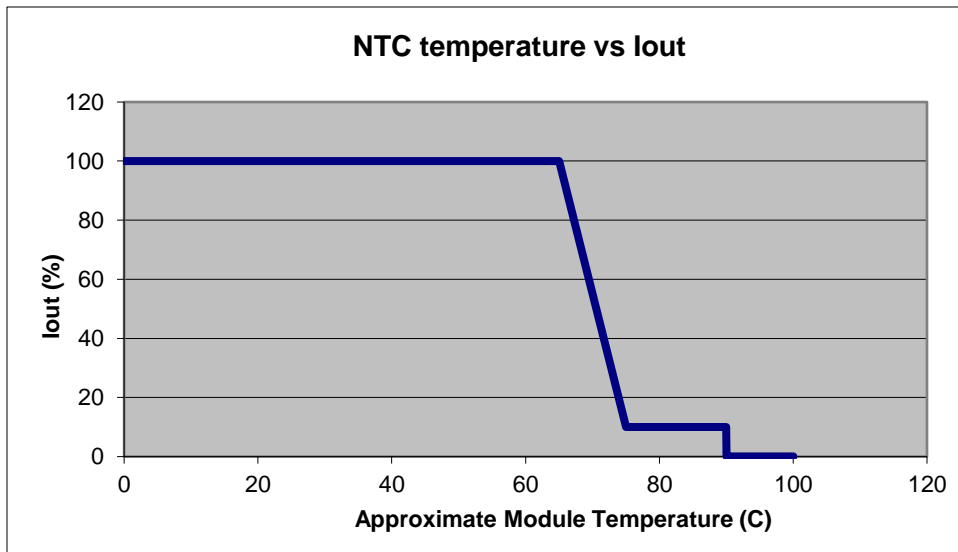

(Example with the Murata NTC p/n NCP18XV103J03RB)

Application and operation performance specification information subject to change without notification.

Life Rating Prediction

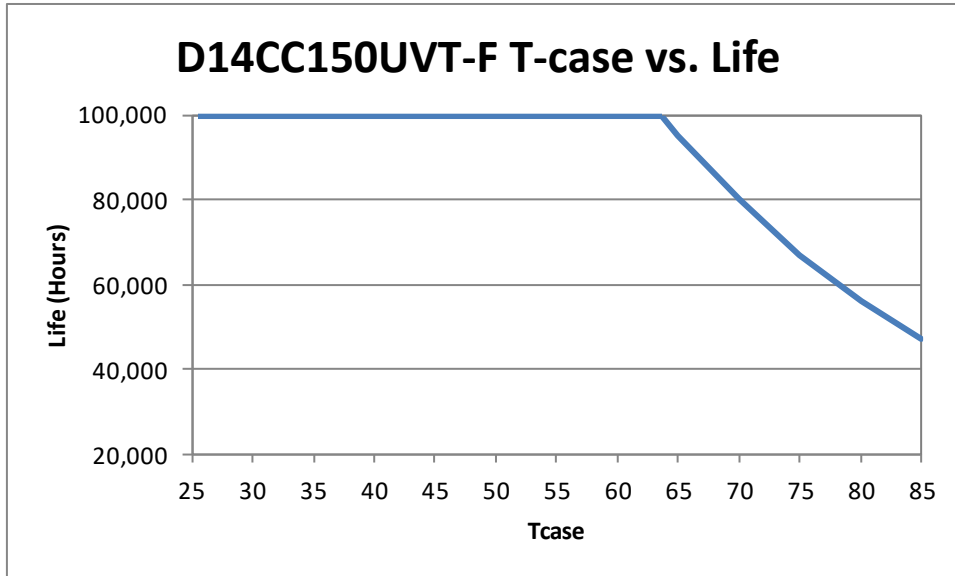

The Data curve provided predicts the LED Driver life based on the case temperature measured at the Tc location identified on the label or specification sheet. The Telecordia SR-332 standard is used to generate the prediction curves.

Dimensional Diagram

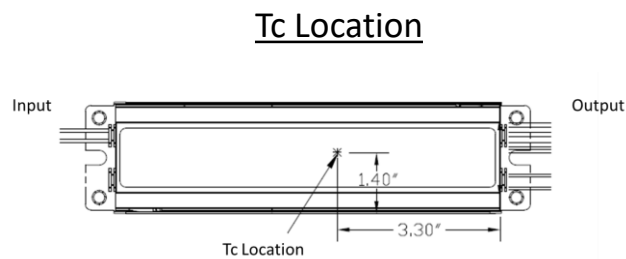
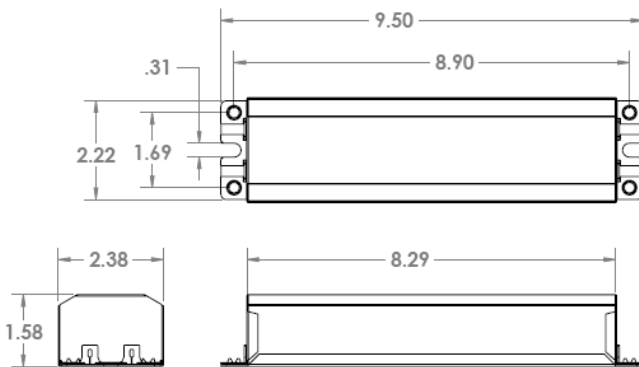

Warranty:

Universal Lighting Technologies warrants to the purchaser that each power supply will be free from defects in material or workmanship for a period of 5 years from the date of manufacture when properly installed per instructions and under normal operating conditions of use. Call 1-800-225-5278 for technical assistance.

Application and operation performance specification information subject to change without notification.